

OWNER'S MANUAL

Quality. Uncompromised.

ROTEL®



AM/FM
STEREO
DC RECEIVER

RX-2001

WARNING: TO PREVENT FIRE OR SHOCK HAZARD, DO NOT EXPOSE THIS APPLIANCE TO RAIN OR MOISTURE.

Write your **SERIAL NUMBER** here.
The number is located near the name plate on
the unit's rear panel.

SERIAL NUMBER

THE ROTEL CO., LTD.

1-36-8 Ohokayama, Meguro-ku, Tokyo, Japan

INTRODUCTION

We would like to take this opportunity to thank you for purchasing the Rotel RX series receiver. This component offers both high performance and a wide range of functions, and we at Rotel are confident that you will be greatly pleased with its superb sound qualities.

We urge you to read and follow carefully the instructions in this manual in order that you may fully realize and enjoy the potentials of this fine component.



EXCLUSIVE NOTE FOR U.K.

If your unit comes with a 3-core cable without a plug, make certain live, neutral and (where appropriate) earth leads are connected to the proper terminals. Check that the terminals are screwed down firmly and no loose strands of wire are present.

WARNING: THIS APPARATUS MUST BE EARTHED IMPORTANT: The wires in this mains lead are coloured in accordance with the following code:

GREEN/YELLOW: EARTH
BLUE : NEUTRAL
BROWN : LIVE

As the colours of the wires in the mains lead of this apparatus may not correspond with the coloured markings identifying the terminals in your plug proceed as follows.

The wire which is coloured GREEN/YELLOW must be connected to the terminal in the plug which is marked by the letter E or by the safety earth symbol , or coloured GREEN/YELLOW.

The wire which is coloured BLUE must be connected to the terminal which is marked with the letter N or coloured BLUE or BLACK. The wire which is coloured BROWN must be connected to the terminal which is marked with the letter L or coloured BROWN or RED.

The apparatus must be protected by a 3 Amp fuse if a 13 Amp (BS 1363) plug is used. If another type of plug is used a 5 Am fuse or lower must be used, either in the plug or adapter or at the distribution board.

BEFORE ENJOYMENT/ POWER SUPPLY

Follow the instructions below for maximum safety:

1. Use a wall outlet for power supply

Be sure to connect the AC line cord directly to a household wall outlet, and not to an auxiliary outlet on another component. Be certain that the outlet voltage matches the electrical rating of the unit, found on the rear panel name plate.

2. Connecting and removing AC cord

Be sure to connect or disconnect the AC line cord only after turning off the power switch, to prevent possible shock noise or damage to the speakers.

3. Furnished Convenience AC Outlet

Do not connect other appliance(s) to convenience AC outlet if its/their total power consumption exceeds maximum rated watts labeled next to the outlet.

4. Ventilate the unit well

Never block any ventilation holes at the top and bottom of the unit. Be sure also to provide ample ventilation space around the unit. Poor ventilation may result in damage due to excessive heat.

5. Do not open the cabinet

In order to avoid electric shock or damage to the component, never open the cabinet. If a foreign object falls inside the unit by mistake, turn the power off, disconnect the wall plug, and consult a qualified electrician or your dealer.

6. Turn the volume control initially to minimum

When lowering the tonearm of your turntable onto a record, an excess of current in the lower frequency range may cause damage to the speakers. To prevent this, always minimize the volume setting initially.

7. Moving the unit

When transporting, remove the AC cord from the wall outlet and all other connected cords on the rear

panel to prevent wire breakage and short circuits.

8. If the unit gets wet

If the unit should get wet, immediately disconnect the AC cord, and consult your dealer or a qualified electrician.

9. Cleaning and maintenance

Do not use chemicals such as benzine or thinners on the front panel. Always use a soft, dry cloth to clean the unit.

10. Retain the owner's manual

Retain the owner's manual near the unit, and write down the serial number (found on the rear panel) on the cover.

INSTALLATION

Be sure to place the unit in a level and flat place where it is free from humidity, vibration, high temperature and not exposed to direct sunlight.

Be careful not to place the unit in a highly enclosed place such as near a wall or on a bookshelf. A poor ventilation will cause undesirable effects to the unit.

(This unit can be mounted on a EIA/EIJ standard audio-rack. Before mounting on the rack, be sure to read through the rack-mounting instruction. Secure the unit firmly to the rack.)

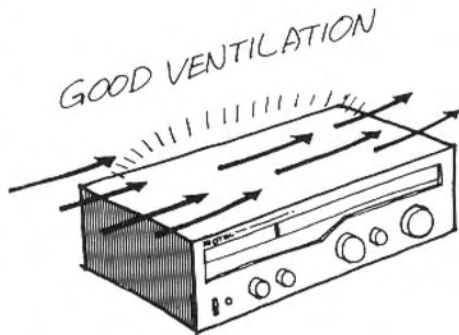

SPEAKERS

Be sure to use only speakers rated at 4 ~ 16 ohms. The unit will accept 2 pairs of speaker systems, but if the 2 systems are to be driven simultaneously, each speaker should be rated at 8 ~ 16 ohms. The speaker impedance may be found on the name plate or the instruction manual of the speaker.

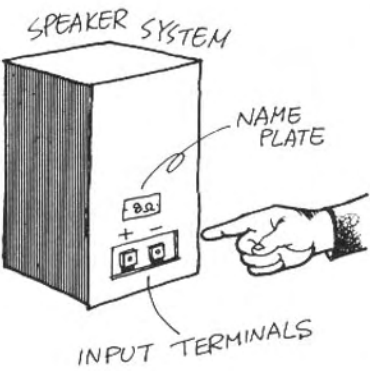

SPEAKERS CONNECTION

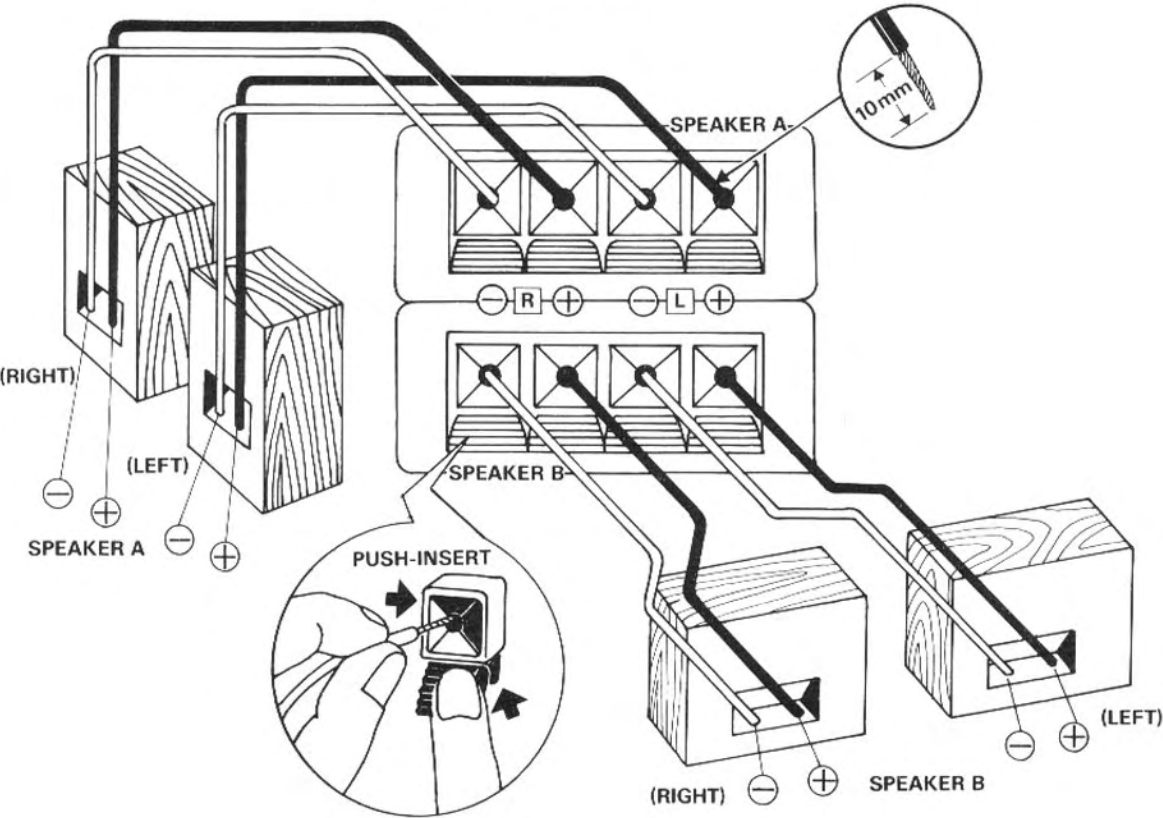

ANTENNA

■ When using the auxiliary T-shape FM antenna and the built-in AM antenna.



Find the most suitable direction and location for the FM indoor antenna, and attach it to the wall, ceiling, etc., with thumbtacks.

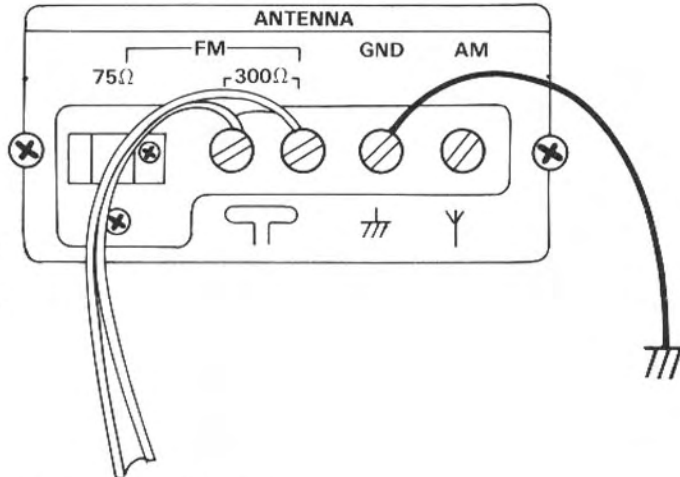

BUILT-IN
AM FERRITE LOOPSTICK ANTENNA

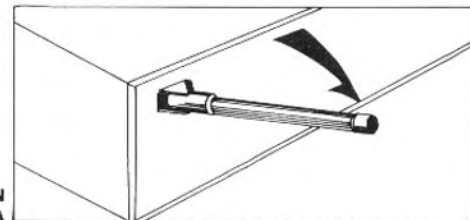

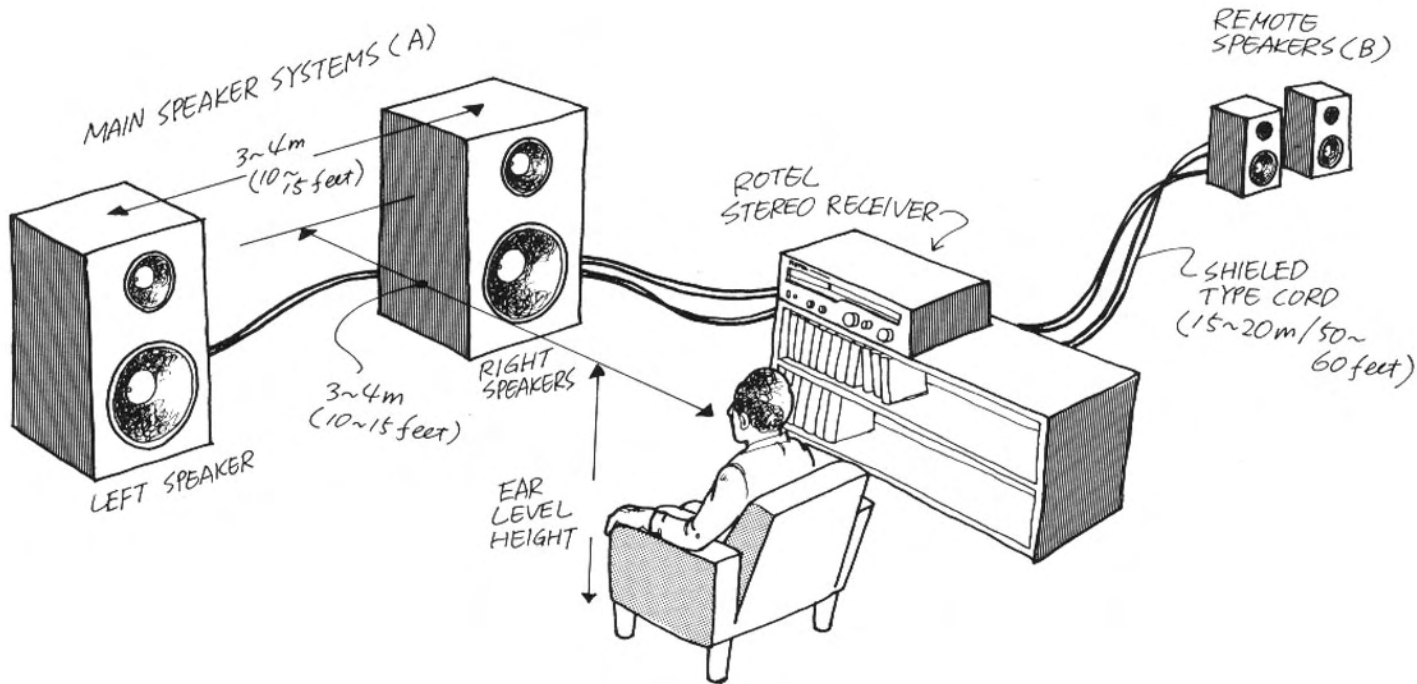

ANTENNE

- When using outdoor AM and FM antennas.

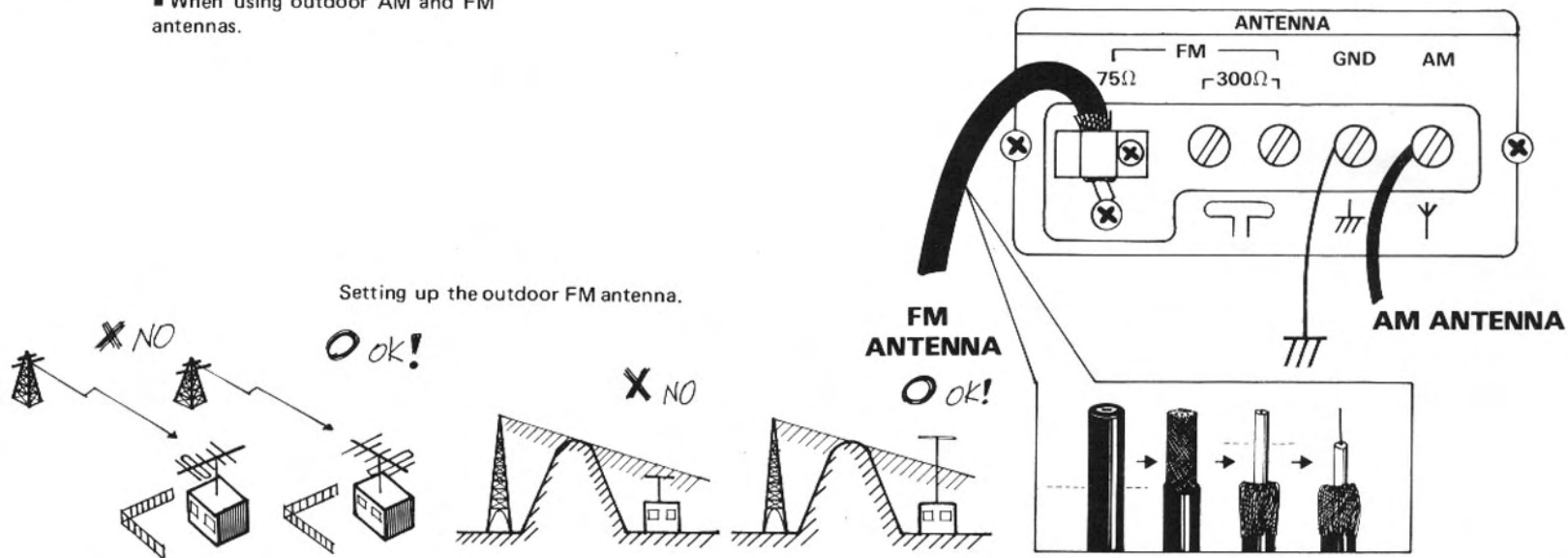



COMPONENTS CONNECTION

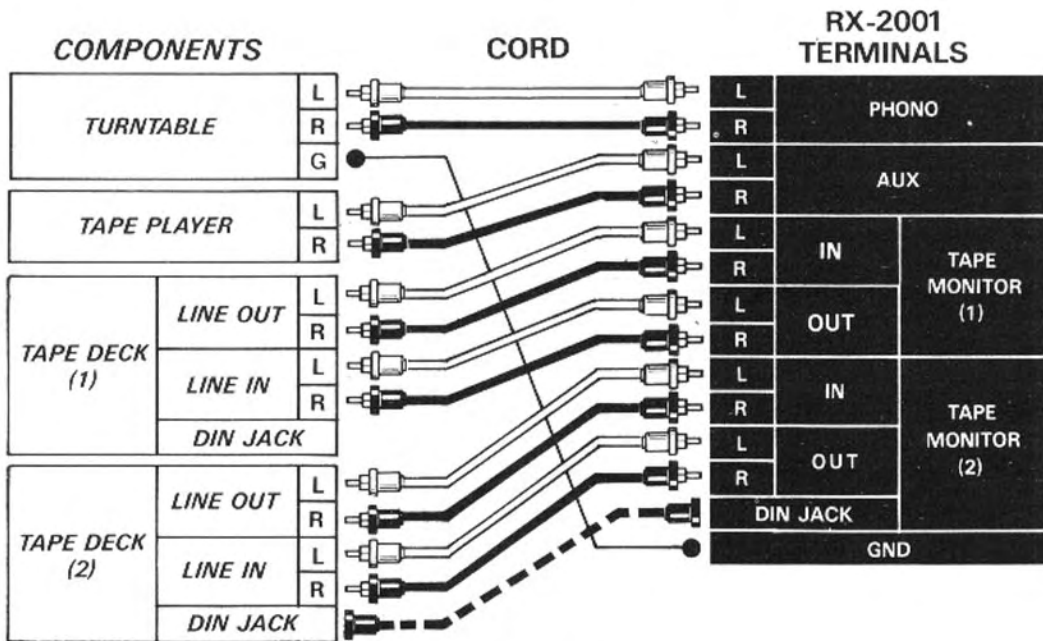

When using DIN type cords, no connections are made using the RCA type pin terminals.

Wenn DIN-Kabel verwendet werden, wird hier nicht verbunden, da RCA-Steckanschlüsse vorhanden sind.

Lors d'utiliser les cordons de type DIN, aucunes connexions ne sont effectuées pas en utilisant les bornes à goupille de type RCA.

SWITCH FUNCTIONS

(1)

Power Switch

Flipping this switch to the 'ON' position turns the power on, and the dial scale lamp will illuminate, indicating that the unit is functioning. (For the first few seconds after this switch is turned on, no sound will be produced due to the action of the protection circuit. This is normal and does not indicate any malfunction in the system.)

(2)

Phones Jack

You may connect a pair of headphones to this jack for private listening. With the speaker selection switch in the 'OFF' position, the headphone level may be adjusted with the volume control.

(3)

Speaker Switches (A & B)

Use this switch to select which of the speaker systems connected to the A and B terminals on the rear panel you wish to listen to. Both systems may also be driven simultaneously.



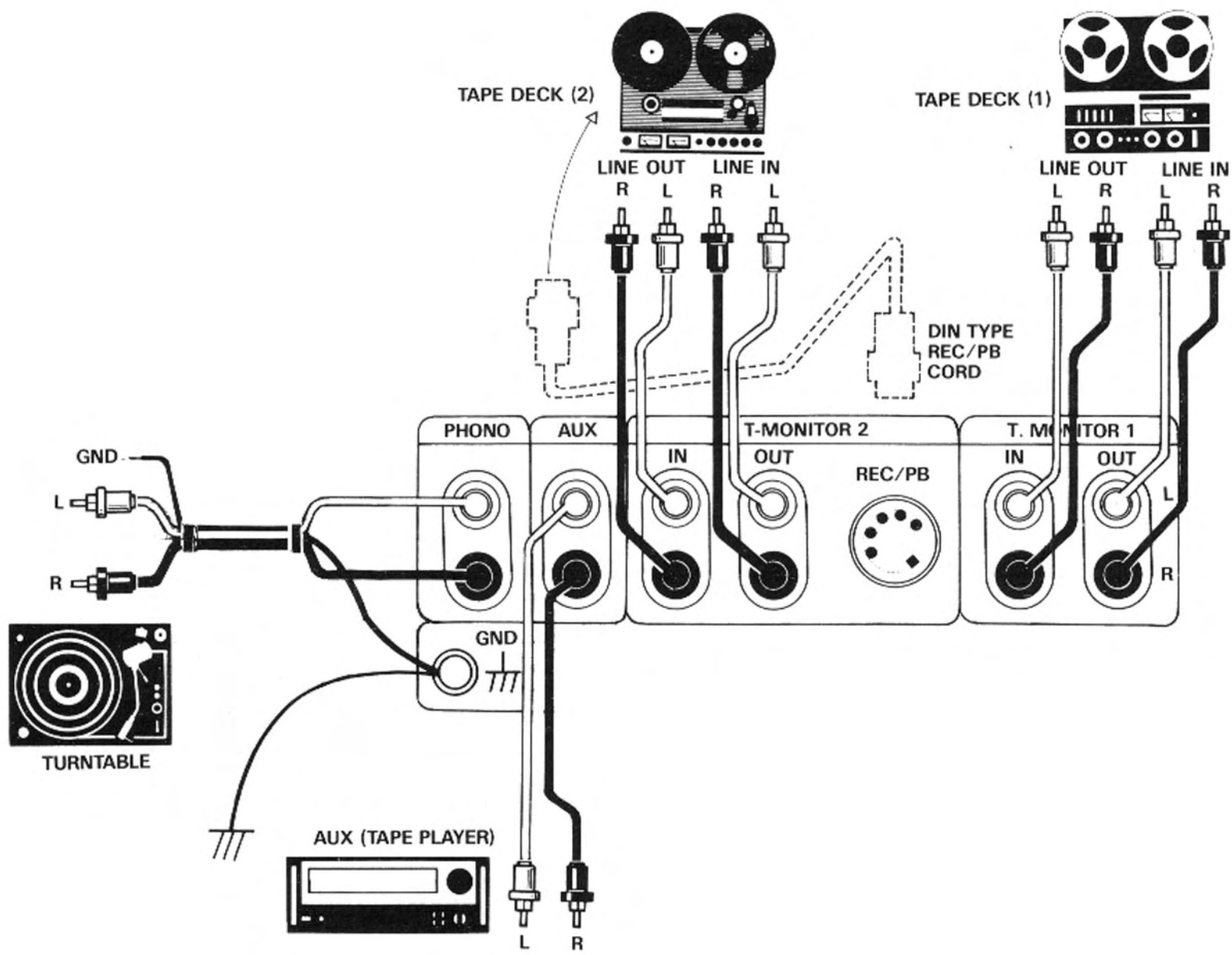

TAPE DECK (2)

TAPE DECK (1)

LINE OUT LINE IN

LINE OUT LINE IN

DIN TYPE
REC/PB
CORD

PHONO

AUX

T-MONITOR 2

T. MONITOR 1

GND

L

R

GND

TURNTABLE

IN

OUT

REC/PB

IN

OUT

L

R

AUX (TAPE PLAYER)

L

R

(4) Bass Control
Turning this control knob to the right of the 'O' position accentuates the lower bass frequencies, while turning it to the left decreases them.

(5) Treble Control
Turning the control knob to the right of the 'O' position accentuates the upper treble frequencies, while turning it to the left decreases them.

(6) Audio Muting Switch
This switch functions to reduce the volume level by one-sixth. When set to the 'IN' position, it will reduce the level indicated on the volume control scale by -15dB. This function is convenient to reduce the volume level momentarily when starting to lower the tonearm onto a record or answering a telephone call.

(7) Loudness Switch
This switch is employed when listening at decreased volume levels, to help overcome the human ear's loss of sensitivity to low and high frequencies. Using this switch boosts bass and treble frequencies, to provide natural sound quality.

(8) Balance Control
In the central position, sound is produced in equal level from both speakers, while turning it to the right decreases the sound from the left speaker, and turning it to the left decreases the sound from the right speaker.

(9) Volume Control
Turn the control clockwise to increase the sound level and counter-clockwise to reduce the level.

(10) Tape Monitor Control
Use this switch to select for tape playback, tape copying, or for other programs.

(11) Function Control
This control is used when listening to programs other than those from the tape deck.

PHONO — Use for turntable listening.
FM, AM — Use for radio broadcasts.
AUX — Use for listening to whatever component has been connected to the rear panel auxiliary terminals, such as tape player, etc.

(12) Tuning Knob (Touch Lock-Off)
This knob is used to select the desired radio broadcast station. When receiving FM broadcasts, the FM signal will be automatically locked the moment the hand is taken away from the knob. (Note: The lock-in will not function when the FM Muting switch is in the 'OFF' position.)

(13) Subsonic Filter
This filter is employed to cut ultra-low frequencies which are below the range of hearing. Depressing this switch will cut unfavorable low frequencies such as those produced by turntable motor rumble.

(14) High Filter
This filter cuts out noise in the high frequency range. Depressing this switch will remove unfavorable high frequency noise such as tape hiss, etc. When not needed, leave in the 'OFF' position.

(15) Indicator Sensitivity Switch
This switch functions to lower the peak power indicator reading by -15dB. Thus, upon pressing this switch, the peak indicator will register a level of -15 dB when at the '0dB' position (and the -18dB reading becomes -33dB). This feature allows you to easily read the indicators at even very low power output levels.

(16) FM Muting Switch
This switch is used to cut inter-station noise when tuning FM stations. When depressed, the muting function is not in operation, as well as the quartz-lock circuit.

(17) FM De-Emph Switch
Press this switch when listening to a Dolby-encoded FM broadcast for proper Dolby sound reproduction. When listening to non-Dolby broadcasts, set the switch to the 'OFF' position.

(18) Peak Power Indicators
These indicators show peak power levels separately for the left and right channels, indicated by the illumination of the LED indicators. The 0 dB position indicates the rated power output level for this unit (at 8-ohm load). (Note: When the Indicator Sensitivity Switch is in the depressed position, the 0 dB position indicates one-sixth (-15 dB) of the rated power output level.)

(19) Station Indicator
This digital scale precisely indicates in numbers the frequency shown on the dial scale.

(20) Lock Indicator (FM only)
This indicator shows that the broadcast signal frequency is locked in (quartz-lock). When the hand comes into contact with the tuning knob, the lock-in is cancelled. (Note: when the FM Muting Switch is in the 'OFF' position, the lock-in will not function.)

(21) FM Center Tuning Indicator
When the dial scale approaches the broadcast signal, one of the right or left LED arrows will go off. The dial indicator should then be moved in the direction of the lighted arrow until the central LED lamp lights up. This position indicates the precise tuning point.

(22) Stereo Indicator (FM only)
This indicator will automatically illuminate whenever an FM program is being broadcast.

(23) Signal Strength Indicator (AM/FM)
The point at which all 7 or most LED indicators illuminate indicates the optimum signal reception.

(24) Dial Scale
The upper scale indicates FM frequencies, while the lower scale is used for AM frequencies.

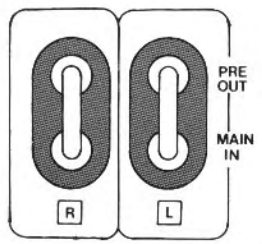

Pre and Main Section Separator Pins
The preamp section (with tuner) and the main amp section of this unit are connected by means of these 2 U-type pins, and the unit is able to function as a receiver. Removing these pins allows each section to function independently. When used as a power amplifier, after disconnection from the pre-amp, the input terminals should be connected to the other pre-amplifier. When the unit is to be used as a pre-amplifier, the output terminals should be connected to the other power amplifier. When using the unit under normal conditions, the pins should be left as they are.

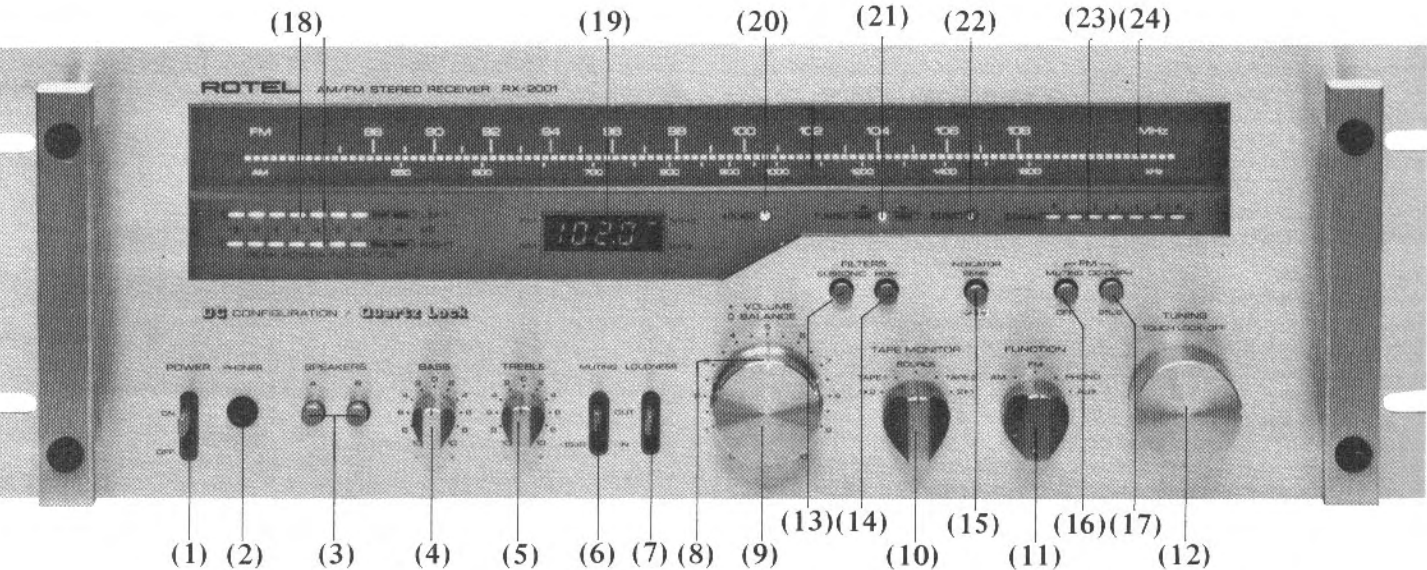

BASIC OPERATION

Before turning your system on, please check the following points:

1. Check to see that all the connections between the various components and speakers have been made properly.
2. Always turn the volume control to the minimum setting before switching on the power.
3. Be sure that you clearly understand the functions of the various switches and controls. Refer to the instruction manual for any that are unclear.
4. Be sure the electric outlet voltage matches that designated for the components.

Note 1: When the power is first switched on, due to the action of the protection circuit, no sound will be produced for a few seconds. This is normal and does not indicate any malfunction in the system.

Note 2: Check the power INDICATORS to be sure that the power output does not exceed the rated input level of your speakers. Use the volume control to make necessary adjustments.



RECEIVING AM/FM BROADCASTS

STEP 1

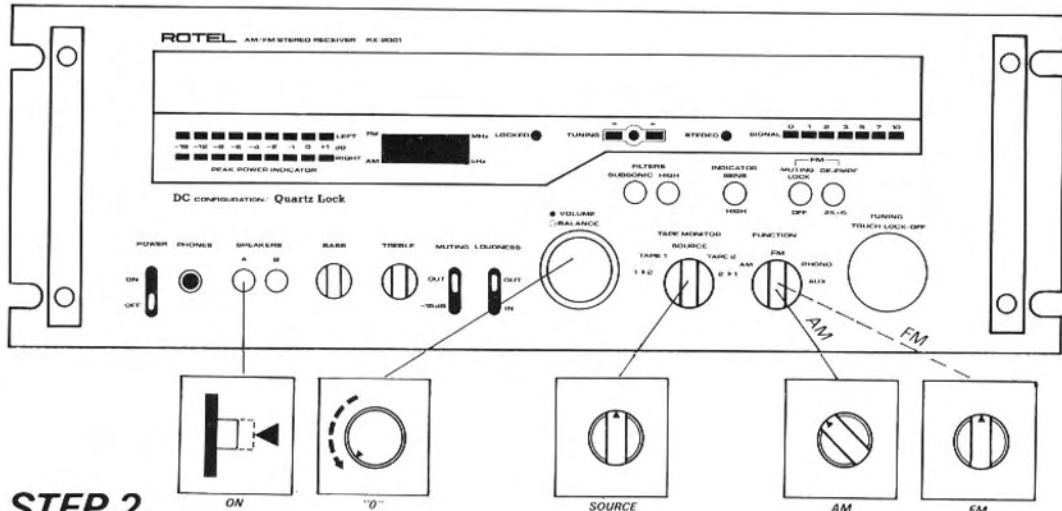

STEP 2

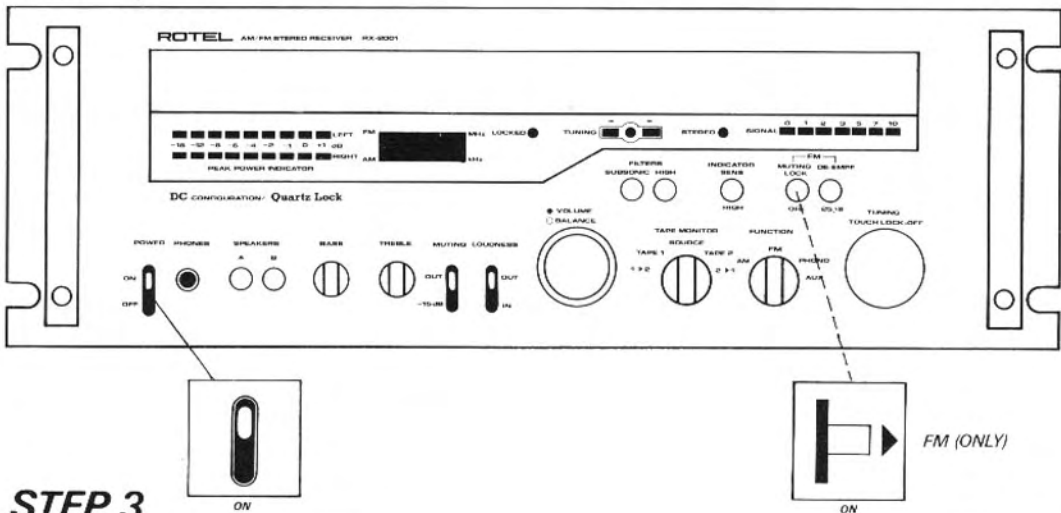

STEP 3

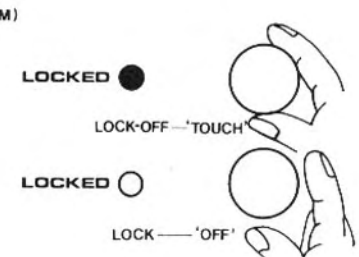
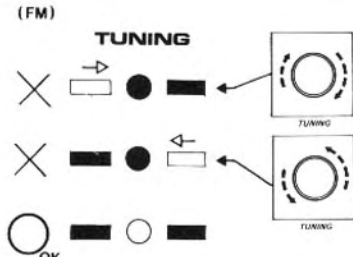
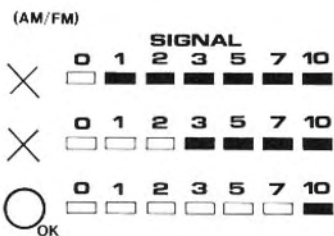
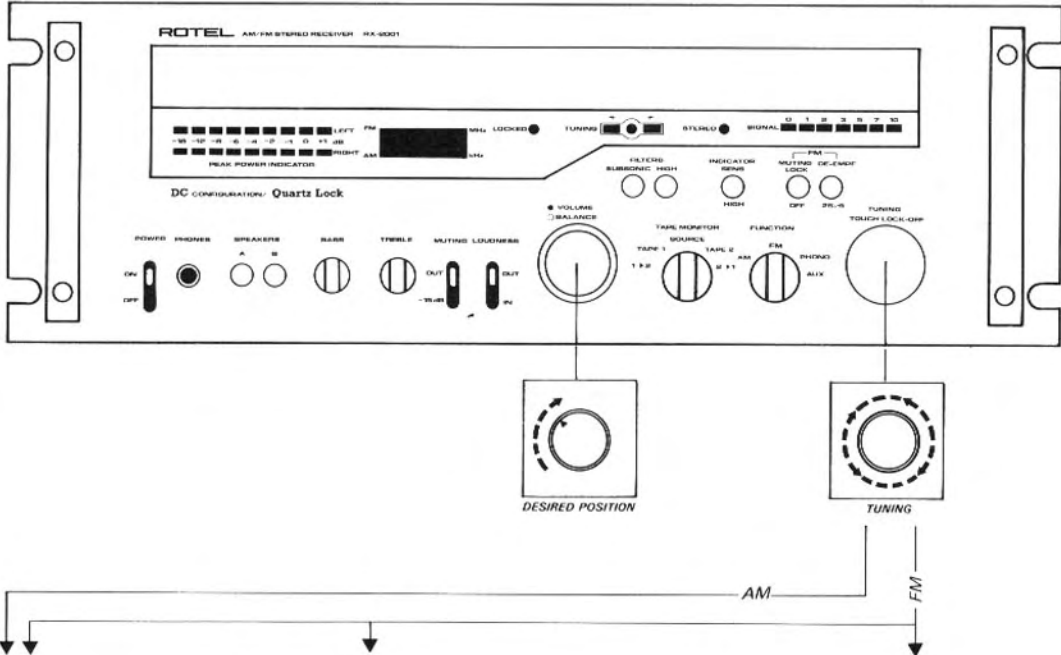

PLAYBACK (TURNTABLE/AUX)

STEP 1

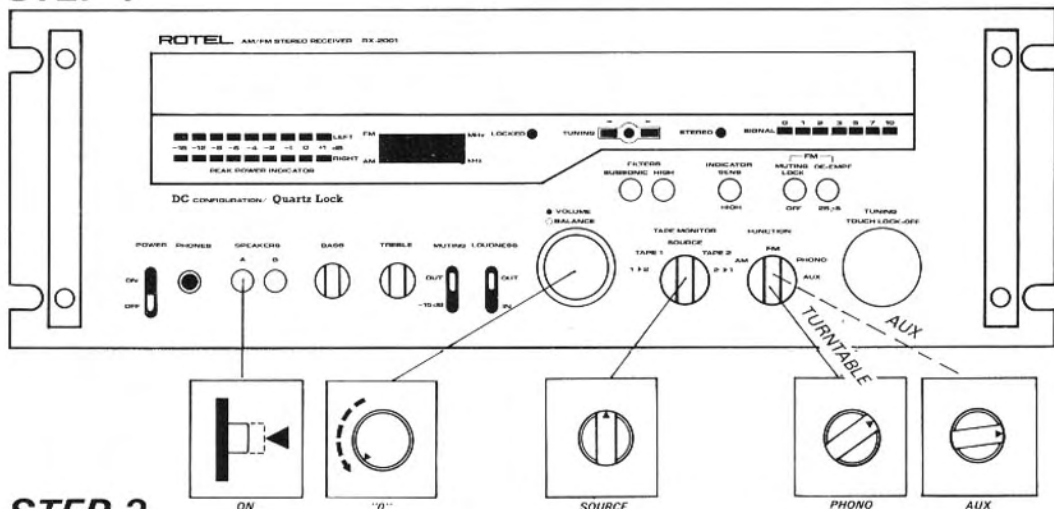

STEP 2

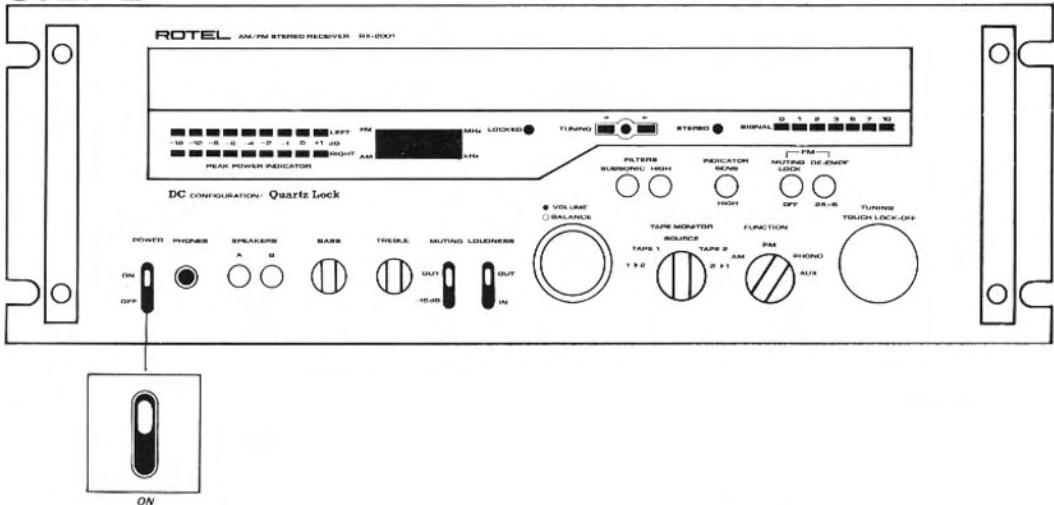

STEP 3



STEP 4

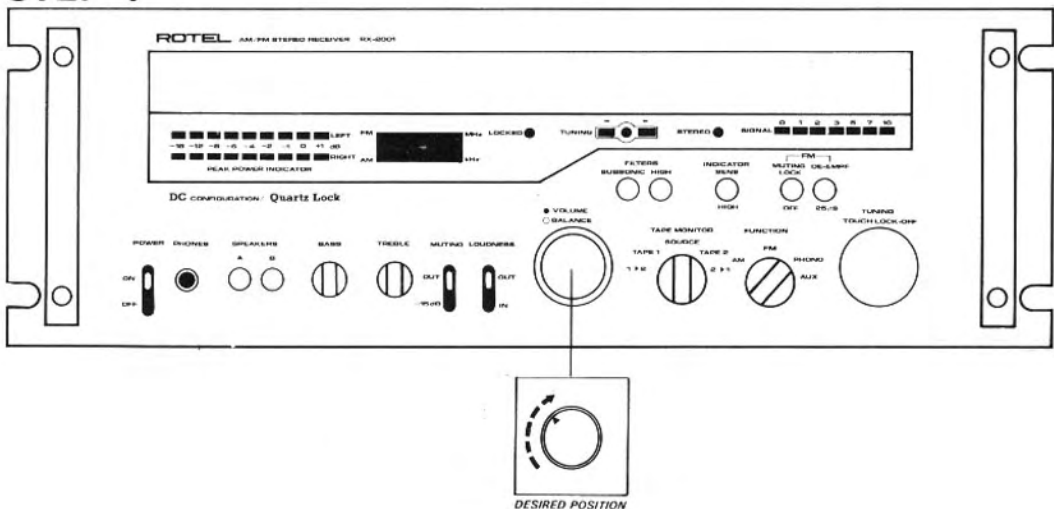

PLAYBACK (TAPE)

STEP 1

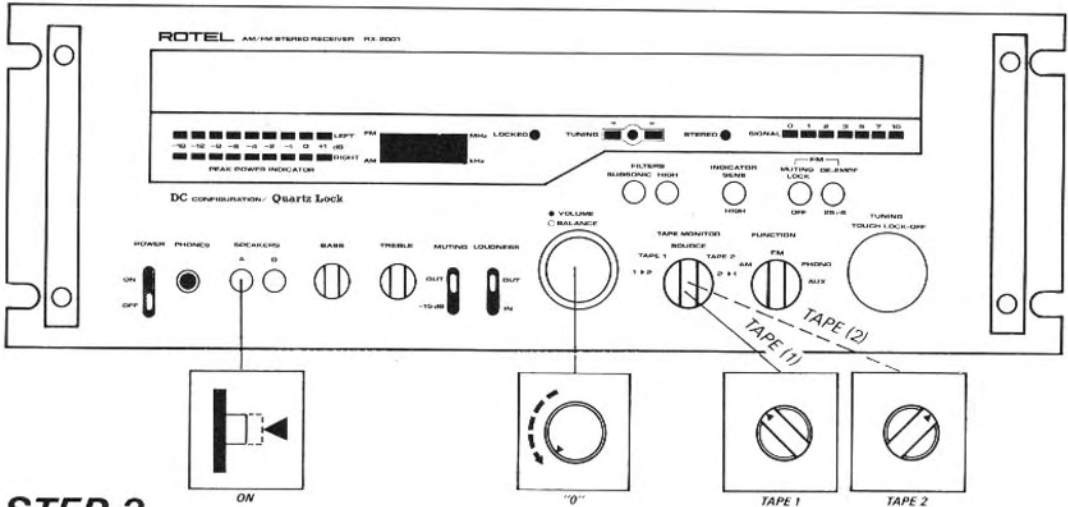

STEP 2

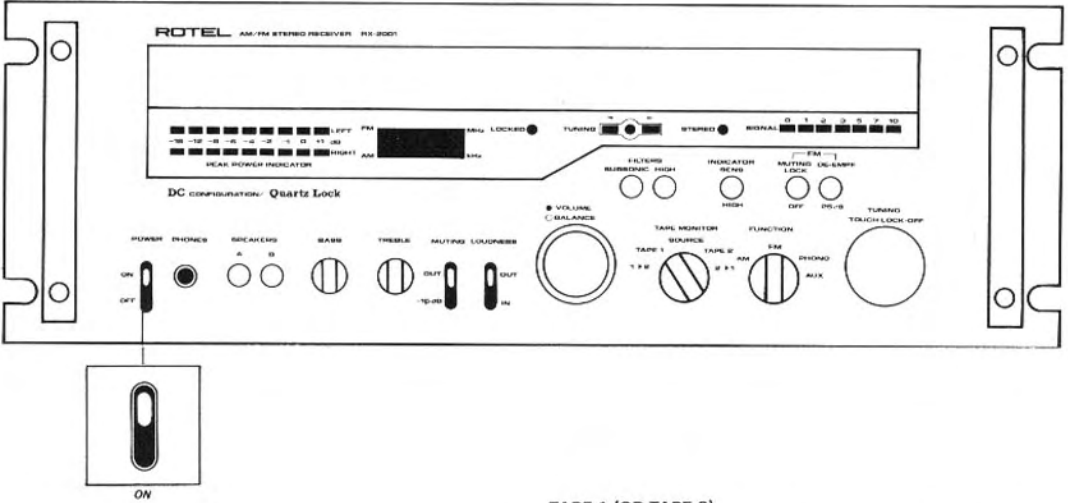

TAPE 1 (OR TAPE 2)

STEP 3



STEP 4

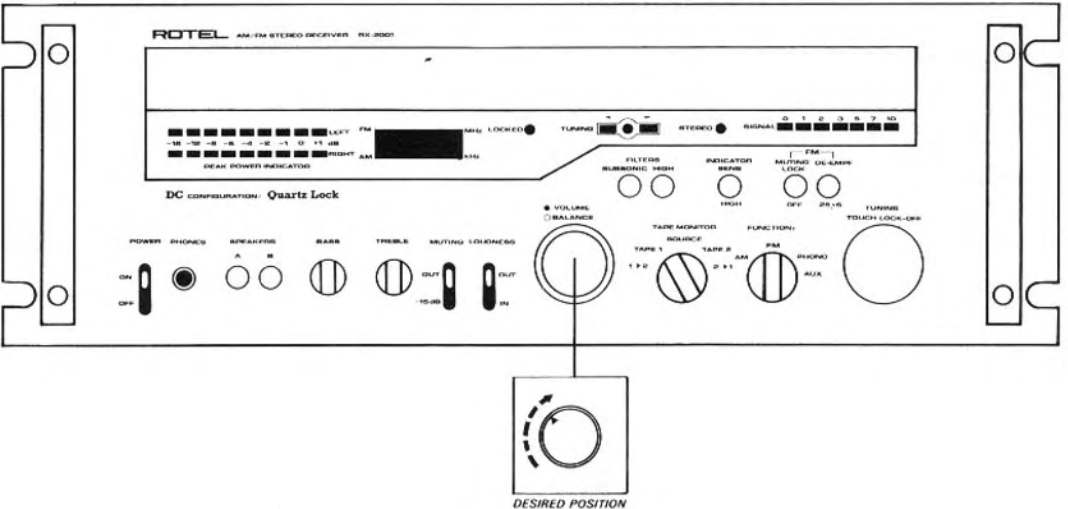

TAPE RECORDING

You can record a program source onto a connected tape deck by setting it to the record mode. Volume, tone, and other sound controls have no effect on the recording signal. When listening to a previously recorded program, these controls may be used to obtain your own preferred sound qualities.

During recording, the monitor switch allows you to listen to either the original source or the recorded sound.

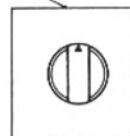
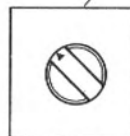
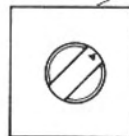
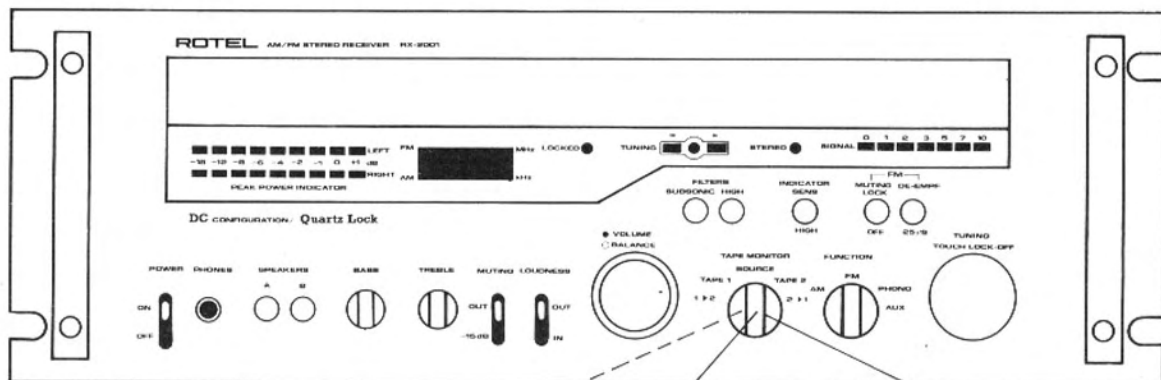

When your deck has 3 heads.

When your deck has no 3 heads.

• LISTENING TAPE RECORDED

• LISTENING THE SOURCE

ENGLISH

You may copy tapes from deck 1 to deck 2 by setting deck 1 in the Playback mode, with tape deck 2 in the Record mode, and the monitor switch in the 1 ▶ 2 position. To copy from deck 2 onto deck 1, set deck 2 in the playback mode, deck 1 in the record mode, and the monitor switch in the 2 ▶ 1 position.

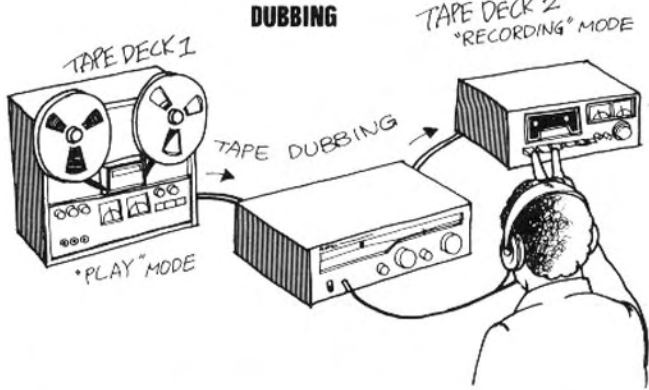

DECK 1 ▶ DECK 2

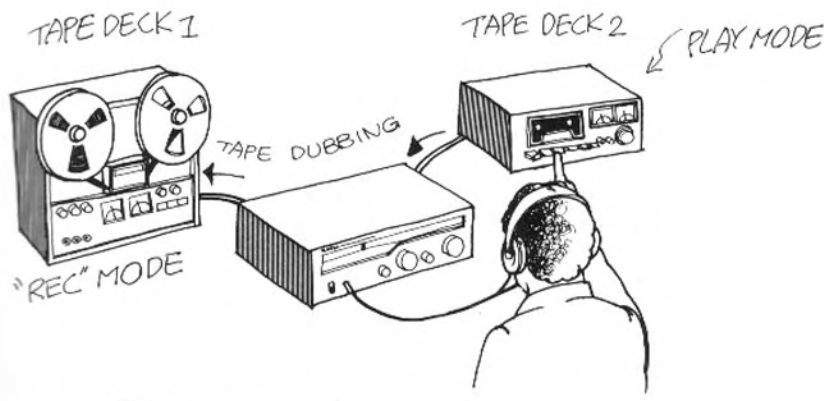
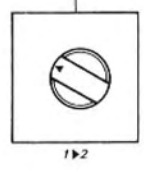
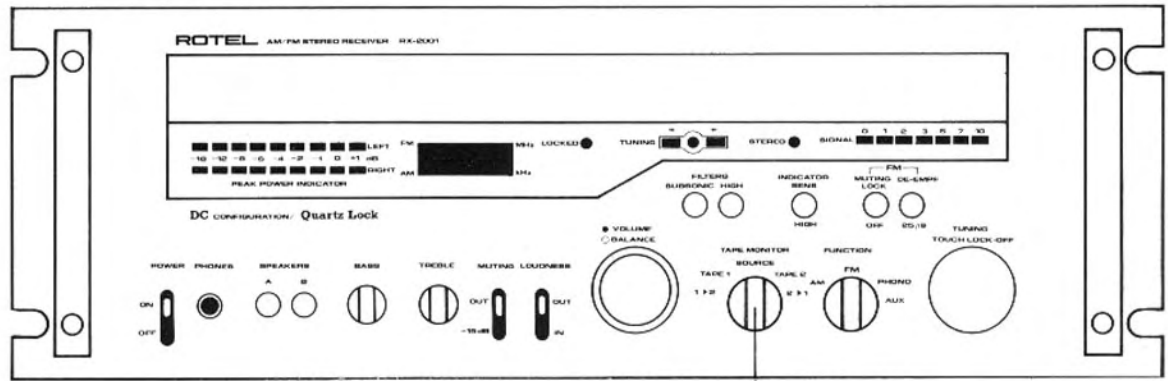

DECK 2 ▶ DECK 1

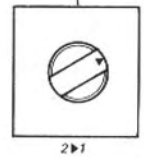
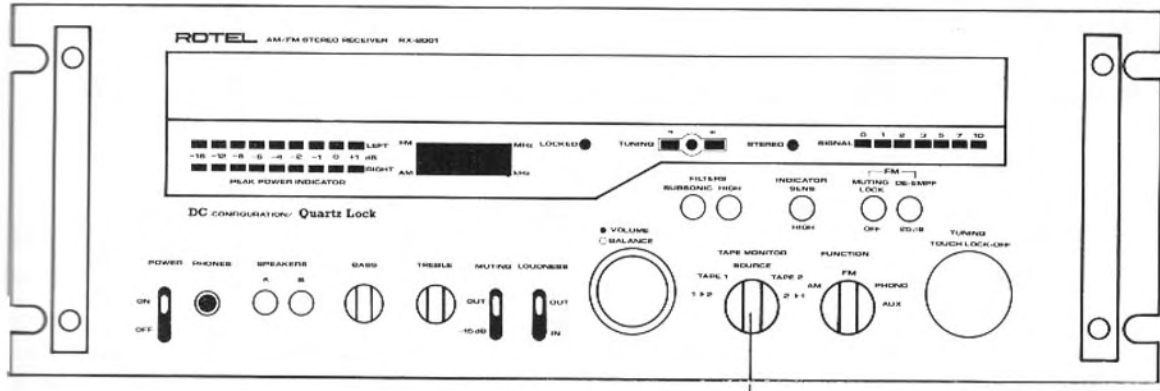

No Sound Is Produced, Sound Quality Is Poor

Possible causes for lack of sound:

1. Speaker switch is in the 'Off' position.
2. Speaker cords are disconnected or broken.
3. Volume is turned to the minimum setting.

Sound Comes From One Speaker Only

1. Balance control is turned all the way to one channel.
2. Component connection cords or speaker cords are disconnected or broken.

No Sound (Except From Tape)

Check the tape monitor switch to see if it is turned to the 'Source' position or not. It should be set at the "Source" position when listening to programs other than tape.

Stereo Sound Seems Unnatural

1. Cord connections are improperly made.
2. Mode switch is turned to 'Monaural' position.

Before concluding that there is some malfunction in the system, be sure to carefully reread the manual.



HUM AND NOISE

In any high fidelity installation, hum may be caused by the interconnection of a record player, tuner and amplifier, and speakers as result of the cables, different grounds or locations of components. If hum is experienced with your unit, disconnect everything but the speakers from the unit. If the hum persists, reverse the power plug at the power source.

Plug in the record player and if hum or howling appears, move the record player away from the speakers as much as possible.

Note hum may also be induced by defective connection cables or by running these cables too close to a strong AC field.

When your unit picks up noise during the reception of broadcasts, causes are mostly due to external objects such as fluorescent lamps and house appliances using motor or thermostat, or thers that may induce the noises.

Either relocating the unit away from the noise sources or using an improved outdoor antenna may readily solve the problem.

In the event you cannot find the causes, consult your dealer or a qualified electrician.

THE PROTECTION CIRCUIT

If no sound is produced after performing the previously mentioned checks, the reason may be due to the functioning of the protection circuit. First, turn off the power and disconnect the plug from the electrical outlet, and check to be sure that the speaker cables are not short circuited. Also, if two pairs of speaker systems are being used simultaneously, check to see whether or not the impedance of each speaker exceeds 8 ohms (if it is below 8 ohms, the speakers will be overloaded due to low impedance). After checking the above points, turn the power on, and the protection circuit will be automatically deactivated and the unit start, functioning again.

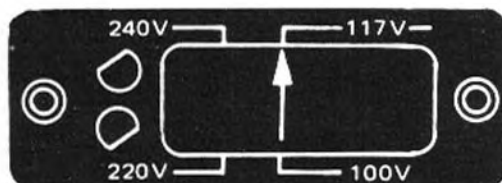

VOLTAGE SELECTION

Not available for U.K., Canada and Scandinavia

The receiver is a variable voltage equipment that can run on 100V, 117V, 220V or 240V power supply. Your unit comes already preset at the proper voltage for use in your area, however, if you move to an area where the power supply voltage is different, the voltage setting can be manually changed. **BE SURE THAT YOUR UNIT IS NOT CONNECTED TO THE POWER SOURCE BEFORE ATTEMPTING TO MAKE THIS CHANGE.**

To change the voltage setting, remove the name plate on the rear panel and locate the VOLTAGE SELECTOR (see figure left). Pull up the voltage selector plug which has a white arrow on its top. Reinsert the plug to the selector base so that the head of the arrow lines up with the pointer line of the voltage you desire.

SPECIFICATIONS

POWER AMPLIFIER SECTION:

Continuous power Output: 75 watts* per channel, min. RMS, both channels driven at 8 ohms or 80 watts* per channel at 4 ohms from 20 to 20,000Hz with no more than 0.03% total harmonic distortion.

Total Harmonic Distortion: No more than 0.03% (continuous rated power output)
No more than 0.03% (38 watts per channel power output 8 ohms)
No more than 0.02% (1 watt per channel power output 8 ohms)

Intermodulation Distortion: No more than 0.03% (continuous rated power output)
No more than 0.03% (38 watts per channel power output 8 ohms)
No more than 0.02% (1 watt per channel power output 8 ohms)

Output: Speaker A, B (4 - 16 ohms)
A + B (8 - 16 ohms)
Headphone 4 - 16 ohms
Damping Factor 50 (1kHz)

PRE AMPLIFIER SECTION:

Input Sensitivity/Impedance:
PHONO 2.5mV/50 kohms
AUX 150mV/50 kohms
TAPE IN 150mV/50 kohms

Overload Level (Max. Input Level) (T.H.D. 0.1%, 1kHz)
PHONO 250mV
AUX Not less than 5V

Output Level/Impedance:
TAPE OUT 330mV/3.2 kohms
TAPE OUT (DIN) 100mV/80 kohms

Frequency Response:
PHONO (MAG) 30Hz to 15,000Hz
 $\pm 0.2\text{dB(RIAA)}$
AUX, TAPE IN 10Hz to 60,000Hz +0.5dB,
-1dB

Tone Control:
BASS $\pm 10\text{dB}$ (25Hz)
TREBLE $\pm 10\text{dB}$ (10kHz)

Filter:
HIGH8kHz (12dB/oct)
LOW15Hz (12dB/oct)
Loudness Contour +10dB (100Hz), +4dB
(10kHz)

(Volume control set -40dB position)

Hum and Noise (IHF, A network, rated power):
PHONO (MAG) 80dB
AUX, TAPE IN 90dB

FM TUNER SECTION:

Usable Sensitivity:
Mono 1.7 μV (9.8dBf)
Stereo 3.8 μV (16.7dBf)

50dB Quieting Sensitivity:
Mono 3.0 μV (14.6dBf)
Stereo 38 μV (37dBf)

Signal-to Noise Ratio (at 65dBf):
Mono 75dB
Stereo 70dB

Distortion: (65dBf):
100Hz 0.1% (mono) 0.2% (stereo)
1kHz 0.1% (mono) 0.2% (stereo)
6kHz 0.2% (mono) 0.25% (stereo)

Frequency Response 30Hz to 15,000Hz +0.3dB,
-1dB

Capture Ratio 1.0dB
Alternate Channel Selectivity 75dB
Spurious Response Ratio 75dB
Image Response Ratio 60dB
IF Response Ratio 70dB

AM Suppression Ratio 55dB
Muting Threshold 14dBf
Stereo Separation 40dB (1kHz) 30dB (50 to
(15,000Hz)
Subcarrier Product Ratio 50dB
SCA Rejection Ratio 60dB
Antenna Input 300ohms balanced, 75 ohms
unbalanced

AM TUNER SECTION:

Sensitivity 200 $\mu\text{V/m}$
Selectivity 35dB
Signal-to-Noise Ratio 50dB
Image Response Ratio 50dB
IF Response Ratio 50dB
Antenna Built-in ferrite loopstick
antenna

MISCELLANEOUS:

Power Requirements 120V/60Hz or 220V/50Hz or
240V/50Hz or 120, 220,
240V/50 - 60Hz
Power Consumption 550 watts (Max.)
Dimensions (Overall) 483(W) x 170(H) x 342(D)
mm
Weight (Net) 16.0kg

NOTE: Specification and design subject to possible modification without notice.

*Measured pursuant to the Federal Trade Commission's Trade Regulation Rule on Power Claims for Amplifiers. (Applicable to the U.S.A. only)